

Pierre Cabling Shutters

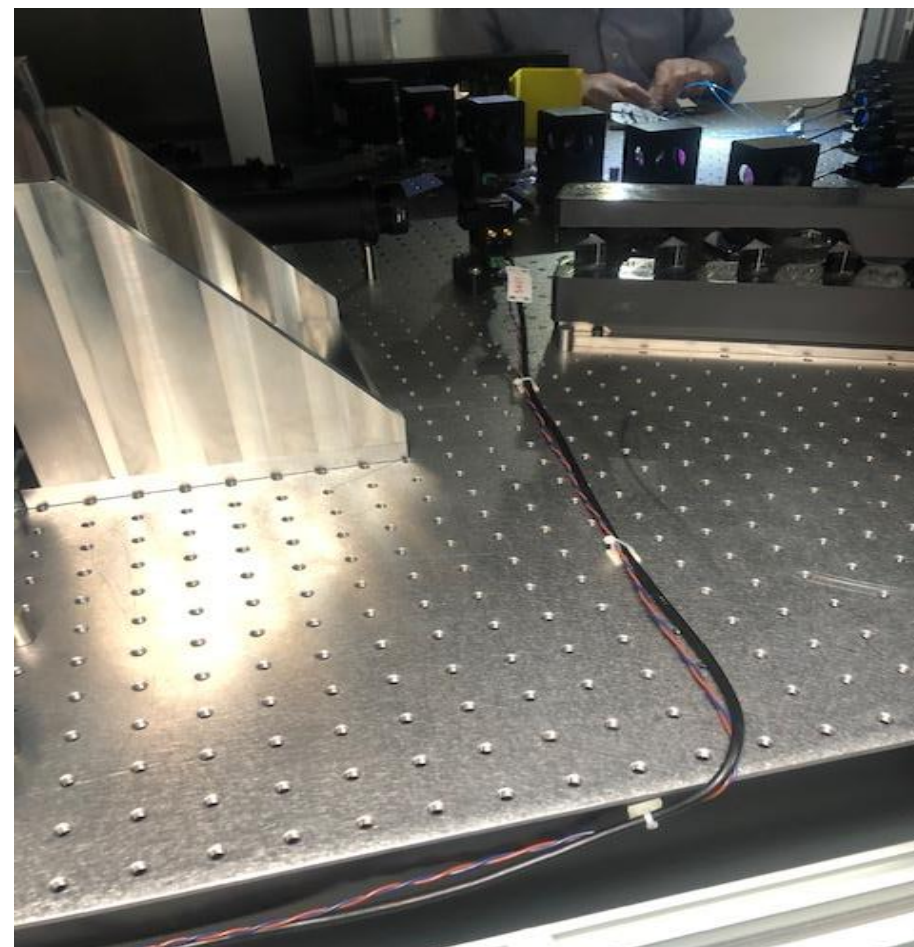

Julien Installing the fibers...

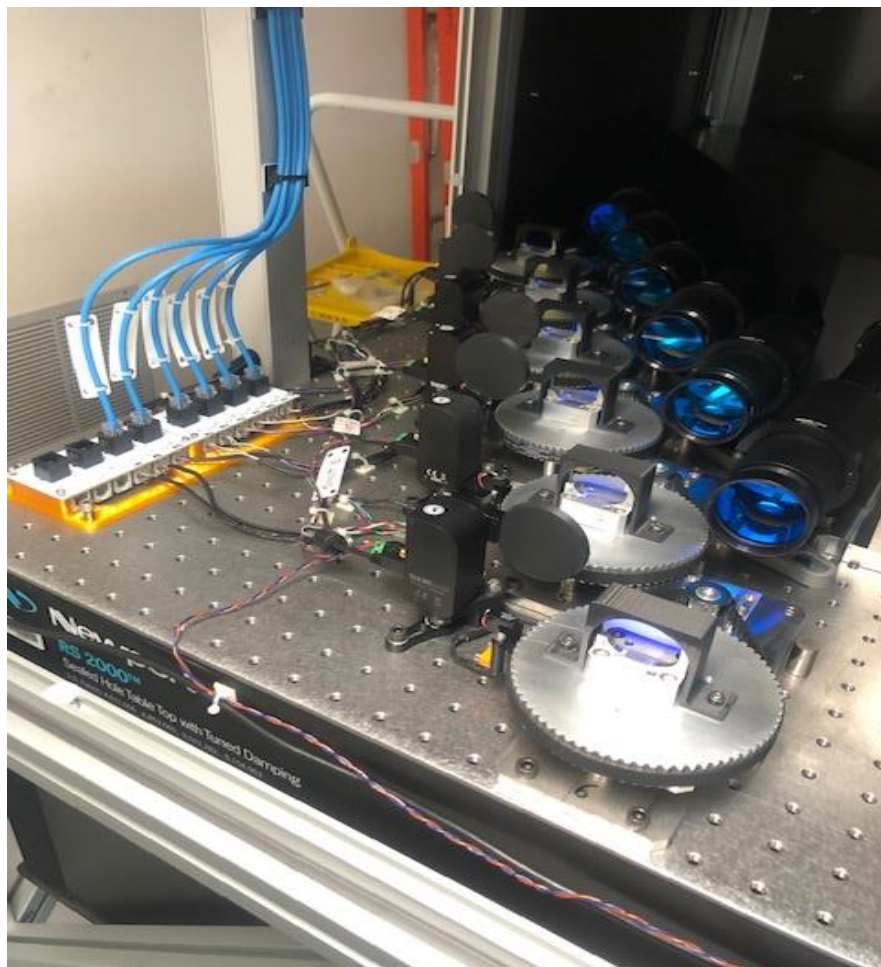
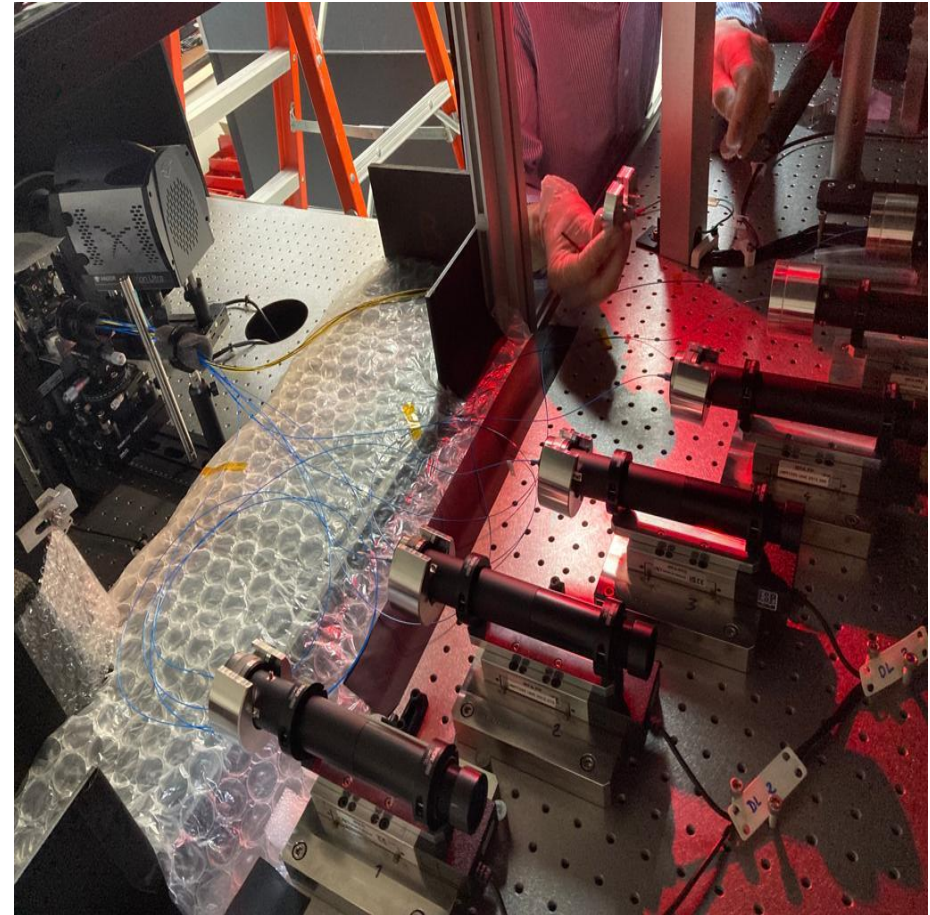
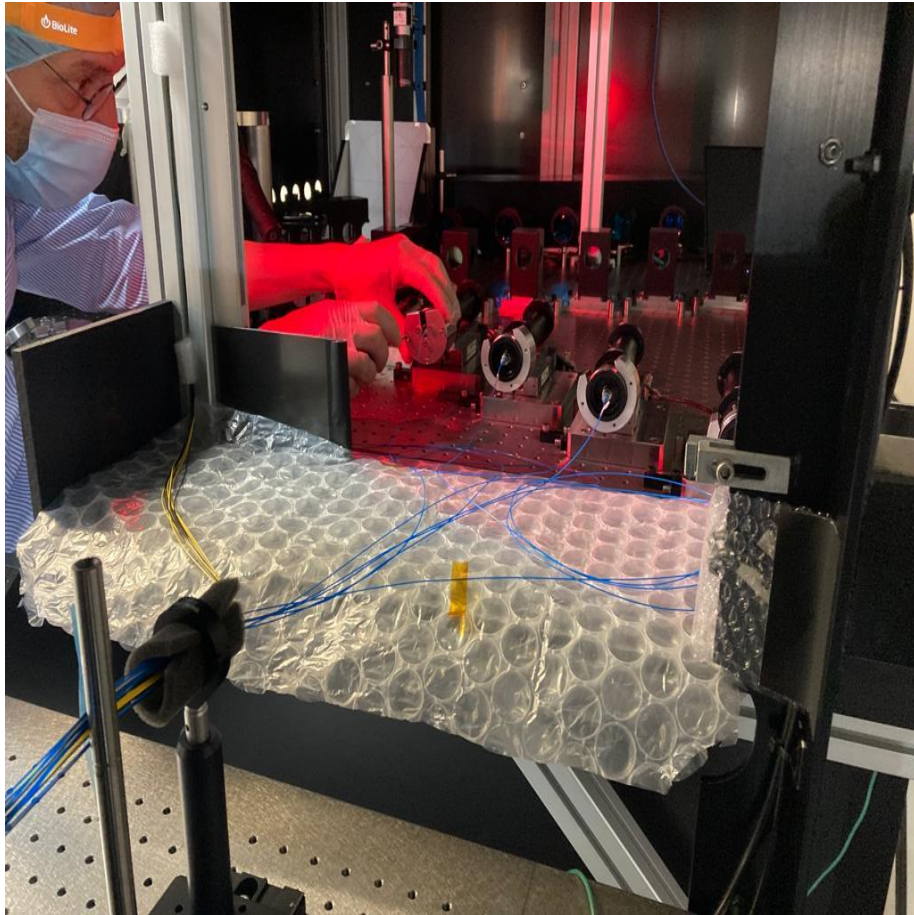

...and blocking the head of fibers

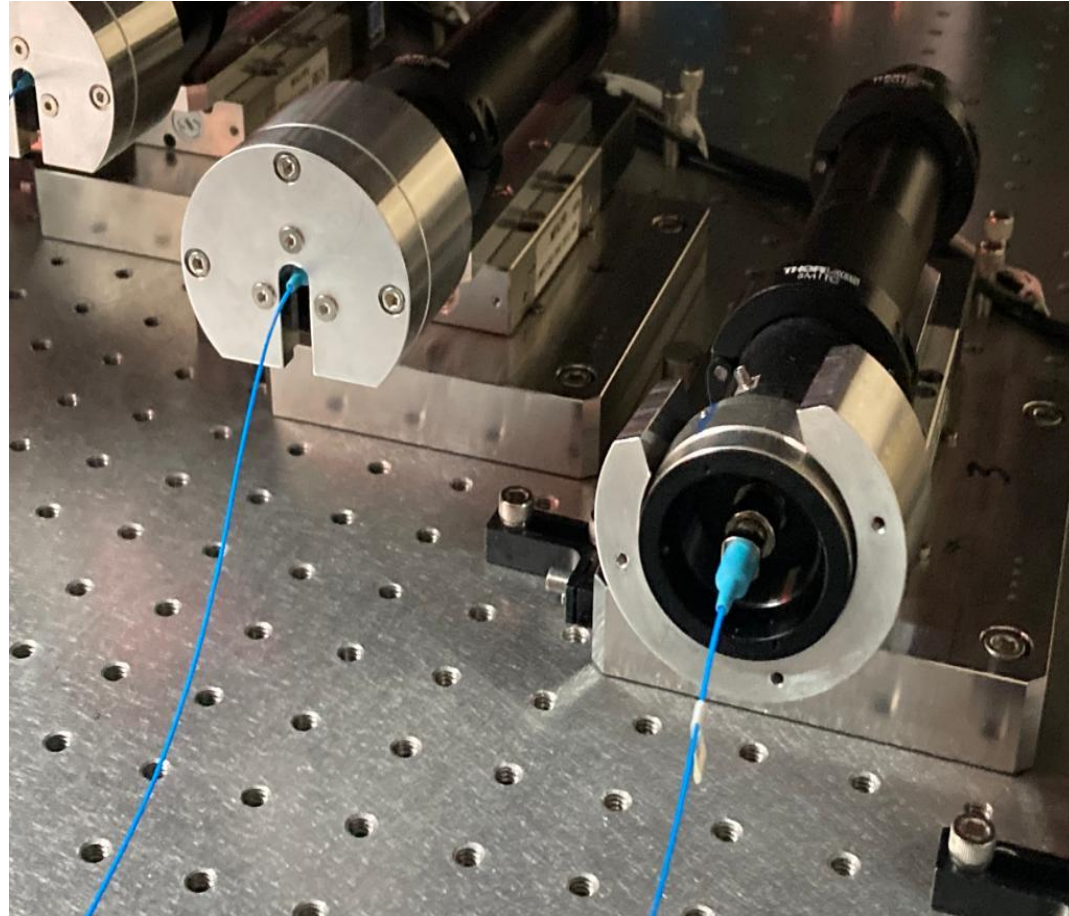

Alignment of the FBI



Setting the collimation with the shear plate

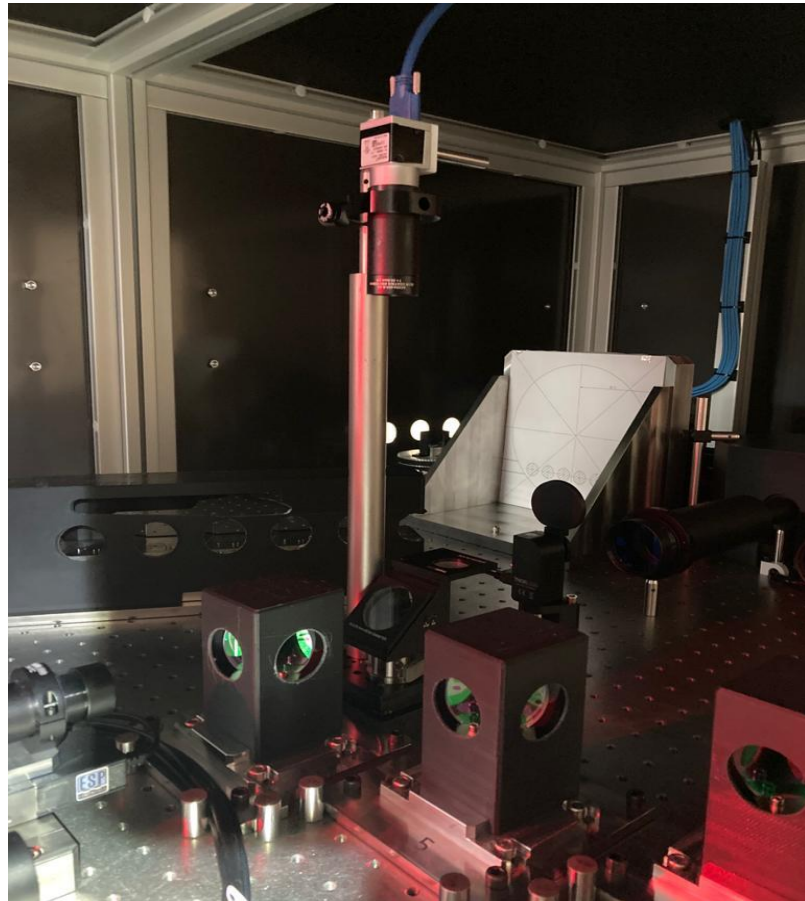

We have added Limit Switches on the STS

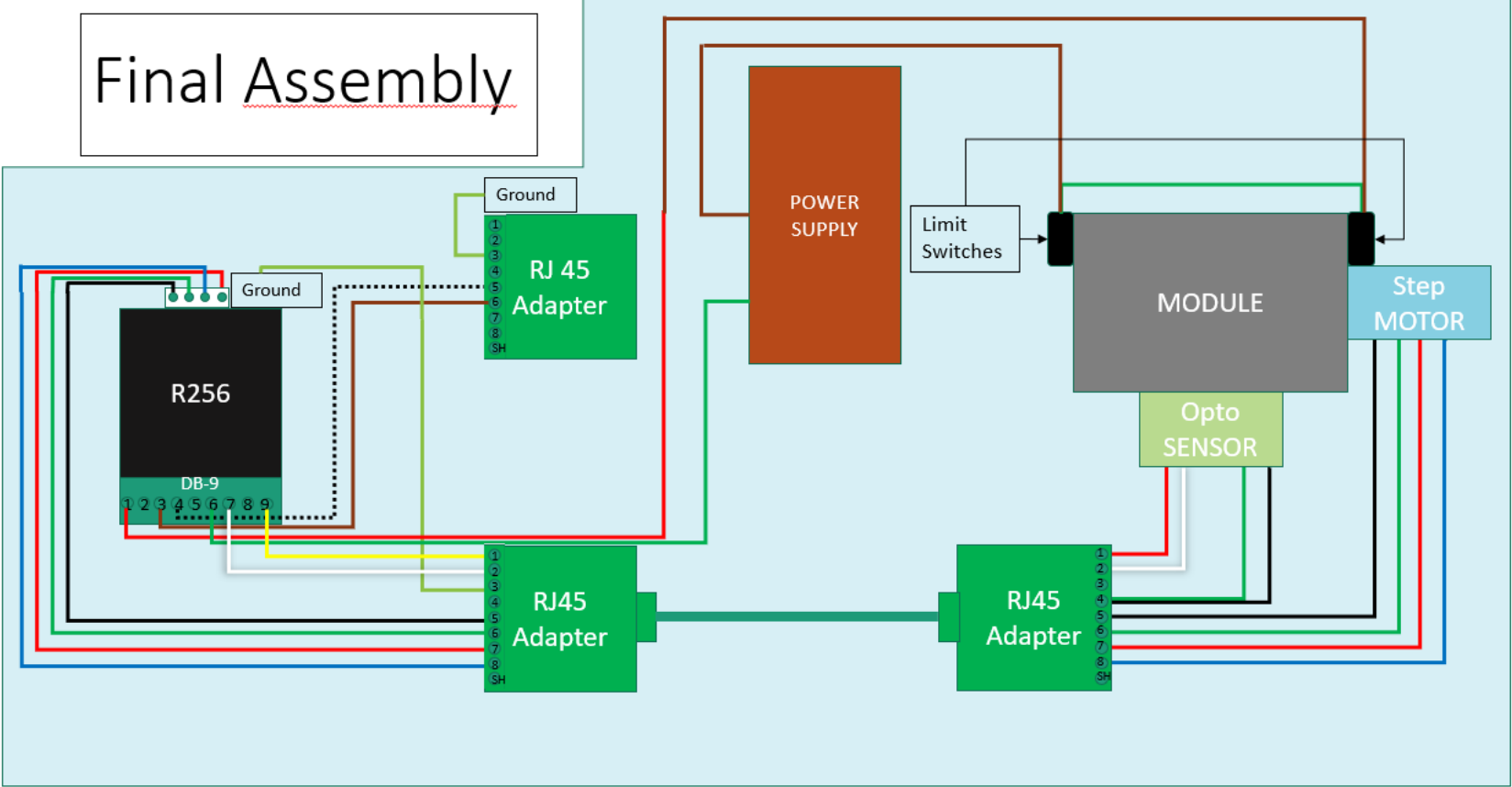

Daniel is about to finish the test on the ADC



Christophe adding the pipes for the chiller



Status of the table the 8th day



Funny time during the lunch break !

